

## SERVICE MANUAL

# T-H300DABmkII

DAB/AM/FM Stereo Tuner

**DAB**  
Digital Audio Broadcasting

**For U.K.**

### CONTENTS

1 SPECIFICATIONS .....	2
2 MICROCOMPUTER PIN FUNCTIONS .....	3
3 EXPLODED VIEWS AND PARTS LIST .....	7
4 PC BOARDS AND PARTS LIST .....	9
5 INCLUDED ACCESSORIES .....	11

### NOTES

- PC boards shown are viewed from parts side.
- The parts with no reference number or no parts number in the exploded views are not supplied.
- As regards the resistors and capacitors, refer to the circuit diagrams contained in this manual.
- $\triangle$  Parts marked with this sign are safety critical components. They must be replaced with identical components - refer to the appropriate parts list and ensure exact replacement.

# 1 SPECIFICATIONS

## FM Tuner

Tuning range .....87.50 – 108.00 MHz (50 kHz steps)  
Signal-to-Noise ratio .....65 dB (Mono)  
60 dB (Stereo)

## AM Tuner

Tuning range .....522 – 1620 kHz (9 kHz steps)  
Signal-to-Noise ratio .....35 dB

## DAB Tuner

Tuning range .....Band 3, 174 MHz – 240 MHz  
Input .....50 ohms, nominal  
Max signal ..... -3 dBm typ  
Sensitivity ..... -96 dBm typ  
Adjacent Channel Rejection .....35 dB typ  
Digital output .....24 bit/48 kHz resolution

Audio output .....Stereo, 2.5 Vp-p

## General

Power requirements .....AC 230 V, 50 Hz  
Power consumption .....9 W (Standby: 3 W)  
Dimensions (W x H x D) .....215 x 93 x 305 mm  
Weight .....2.3 kg

Operating temperature .....+5°C - +35°C  
Operating humidity .....5% to 85% (no condensation)  
Storage temperature .....-20°C - +55°C

Accessories .....AM loop antenna x 1  
FM Lead-type antenna x 1  
DAB antenna x 1  
RCA pin cable x 1

- Design and specifications are subject to change without notice.
- Weight and dimensions are approximate.

## About DAB

With this unit you can receive and listen to Digital Audio Broadcast (DAB) programmes. DAB uses digital, not analogue signals, resulting in near CD-quality audio with virtually interference-free reception. Along with superior quality audio, DAB can also deliver additional audio channels and text. In the future, computer data and images are also possible.

Digital radio is broadcast as groups of data called ensembles or multiplexes. Each multiplex can contain a number of stations (services) and each station contains a primary service and can contain secondary services as illustrated in the following diagram.

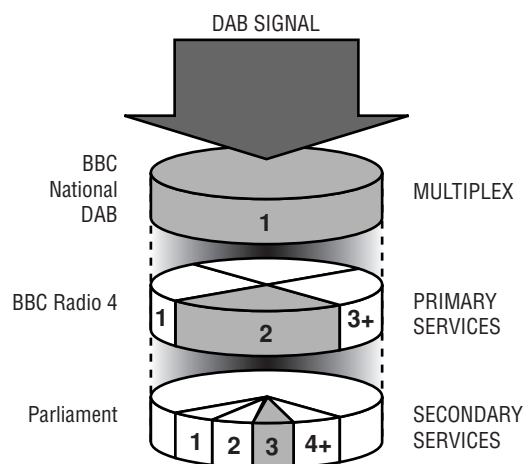

Each multiplex is transmitted in a set frequency range and received by this unit for decoding. You can receive multiplexes broadcast in the 174–240 MHz frequency band and store the services in each multiplex for you to access. The number of multiplexes you receive depend on your location. Channels used in the UK are in the range 10A to 12D.

Multiplexes and stations have labels (names) that are used to identify them. Instead of needing to know the particular frequency of your favourite broadcast, you can simply select the station name. Secondary services and additional data such as text or multiplex info are also available.

# 2 MICROCOMPUTER PIN FUNCTIONS

## 2-1 Pin Assignment

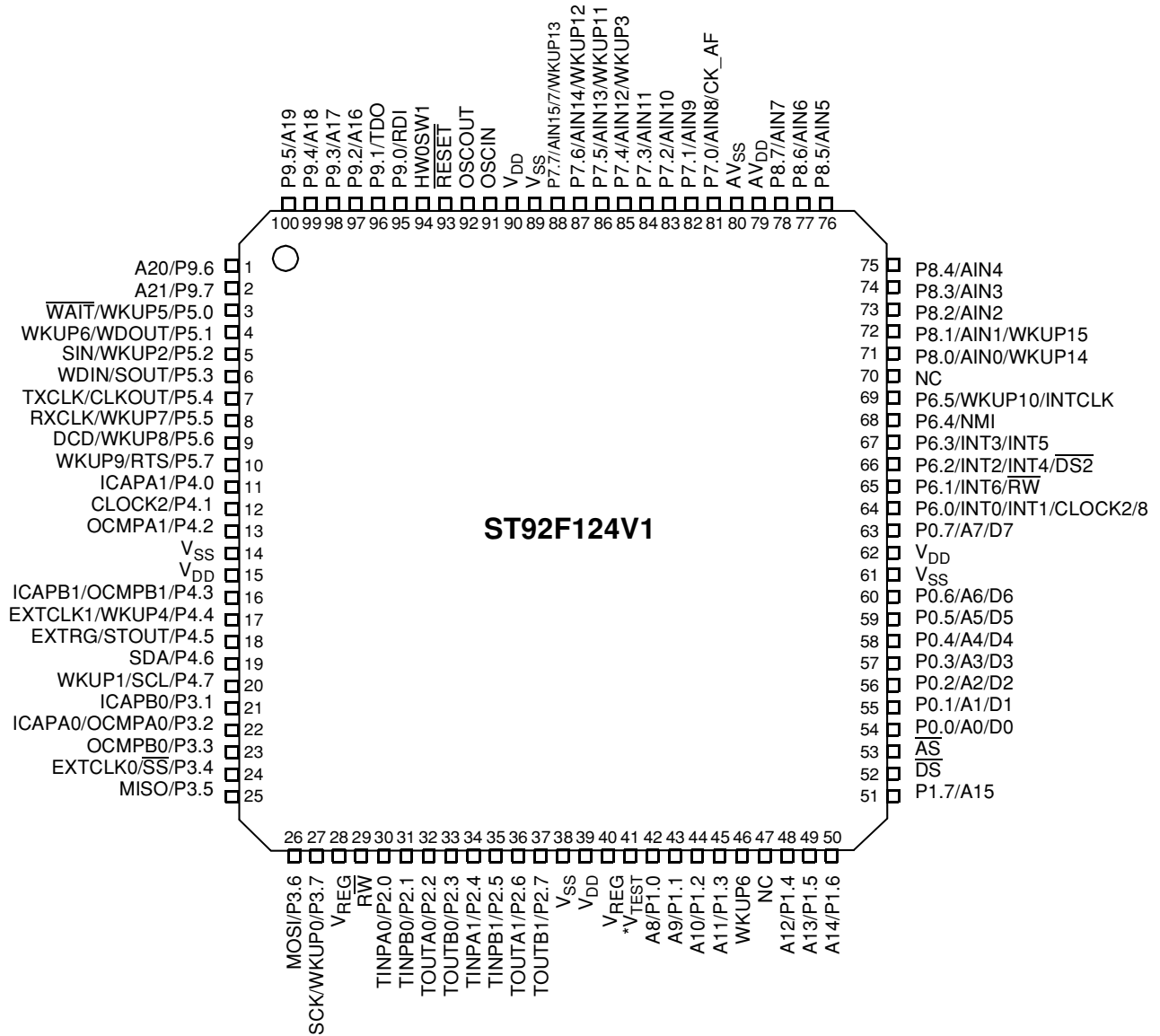

\* V<sub>TEST</sub> must be kept low in standard operating mode.

## 2-2 Block Diagram

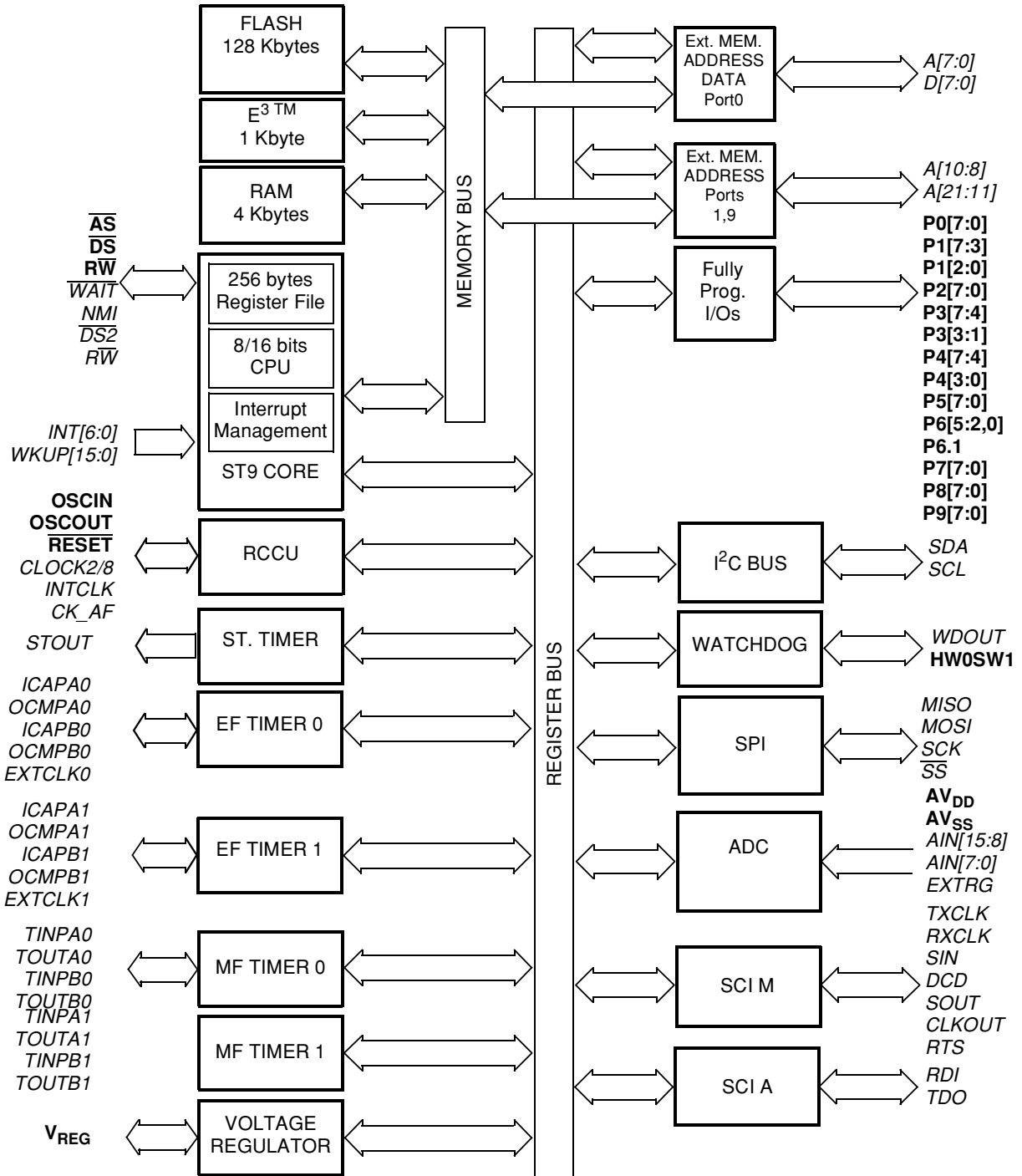

The alternate functions (*Italic characters*) are mapped on Port 0, Port 1, Port2, Port3, Port4, Port5, Port6, Port7, Port8 and Port9.

## 2-3 Pin Functions

PIN No.	NAME	I/O	DESCRIPTION
1	POWER_ON	0	Unit turn on control port ("L")
2	DAB_ON	0	DAB on control port ("L")
3	FM/AM_ON	0	FM/AM on control port ("L")
4	STAND_BY	0	Standby on control port ("L")
5	PLL_DATA	0	PLL_ Data output port
6	PLL_CLK	0	PLL_ Clock control port
7	PLL_CE	0	PLL_Chip Enable control port
8	PLL_DIN	I	PLL Data input port
9	FM/AM_MUTE	0	FM/AM MUTE control port ("L")
10	TUNED	I	Tuner module tuned control port
11	STEREO	I	Tuner module stereo control port
12	REAL_TIME_DATA	I	Real time Data port
13	REAL_TIME_CLK	I	Real time Clock Input port
14	VSS_1	-	GND
15	VDD_1	-	Power supply port (+5V)
16	RTC_OUT	0	Real time Clock Output port
17	NC		
18	DAB_DIN	I	DAB Data input port
19	DAB_DOUT	0	DAB Data output port
20	DAB_CK_OUT	0	DAB Clock output port
21	DAB_CK_IN	I	DAB Clock Input port
22~25	NC		
26	RS_P	0	Register selection port
27	WRITE_ENABLE_P	0	Write enable port
28,29	NC		
30	READ_ENABLE_P	0	Read enable port
31~37	NC		
38	VSS_2	-	GND
39	VDD_2	-	Power supply port (+5V)
40	VREG2	-	
41	V TEST	-	For Flash test purposes port ("GND")
42~44	COB0~COB2		FIP Data output port
45,46	NC		
47~51	COB3~COB7		FIP Data output port
52~59	NC		
60	RDS_DATA	I	RDS Data input port
61	VSS_3	-	GND
62	VDD_3	-	Power supply port (+5V)
63	BUS_OUT	0	BUS output port
64	BUS_IN	I	BUS input port
65	REMOTE_IN	I	Remote unit data input port
66	RDS_CLOCK	0	RDS Clock control port
67	BACK_UP	I	BACK_UP mode control port ("L")
68~71	NC		
72	KEY 1	I	Key 1 control port
73	KEY 2	I	Key 2 control port

PIN No.	NAME	I/O	DESCRIPTION
74	SCROLL_UP	I	Scroll up control port
75	SCROLL_DN	I	Scroll down control port
76~78	OPTION	-	GND
79	VDD_4	-	Power supply port (+5V)
80	VSS_4	-	GND
81	REMOTE_SELECT	I	System/Single Remote select port
82~88	NC		
89	VSS_5	-	GND
90	VDD_5	-	Power supply port (+5V)
91	X_IN	I	Oscillator input port
92	X_OUT	O	Oscillator output port
93	RESET	I	Reset input port ("L")
94	VDD		The software watchdog option port.
95~99	NC		
100	SYSTEM_MUTE	O	System Mute control port ("L")

### 3 EXPLODED VIEWS AND PARTS LIST

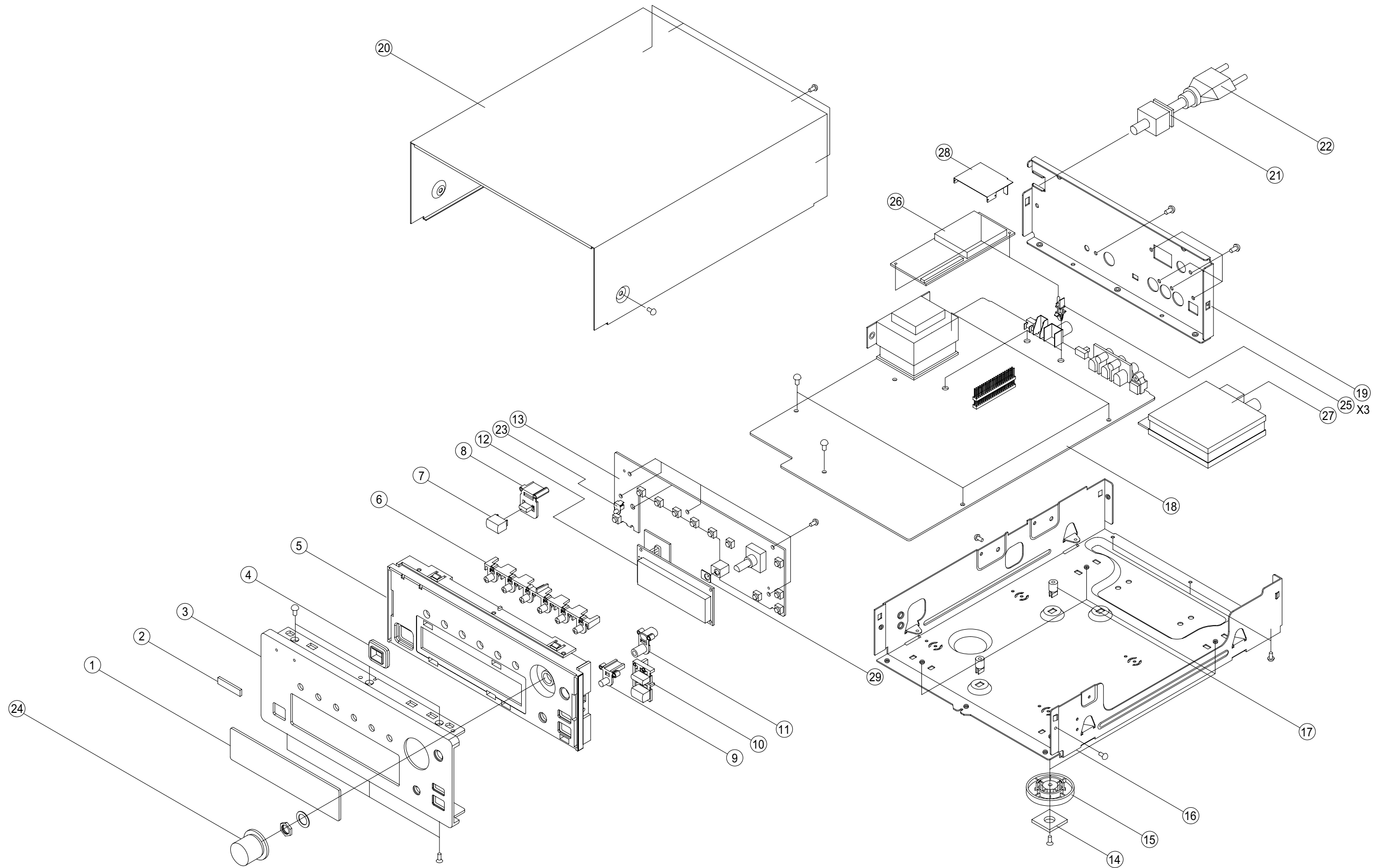

## EXPLODED VIEW LIST

REF. NO.	PARTS NO.	DESCRIPTION	REMARKS
1	CGU1A154W	WINDOW	
2	KGB1A047Z	BADGE, TEAC	
3	CKM1A151YC35	PANEL, FRONT	
4	CGL1A133	INDICATOR, STAND BY	
5	CGW1A387M7G5	PANEL, SUB	
6	CBT1A944M7G5	KNOB, TACT	
7	CBT1A495M7G5	CAP, STAND BY	
8	CBT1A483	KNOB, STAND BY	
9	CBT1A484M7G5	KNOB, DIRECT	
10	CBT1A531M7XG5	KNOB, FM MODE	
11	CBT1A491M7G5	KNOB, RDS	
12	HFL16T202DA1E	VFD, MODULE	
13	COP11701B	PCB ASSY, DAB	
14	KHG1A050Y	CUSHION, FOOT	
15	CKL2A055H45	FOOT	
16	CUA1A158	CHASSIS, BOTTOM	
17	CHE1A023	MOUNT, PCB	
18	COP11701B	PCB ASSY, DAB	
19	CKF1A283Z	PANEL, REAR	
20	CKC1B089S35	CABINET, TOP	
21	△ KHR1A028	BUSHING, AC CORD	
22	△ CJA2E045ZA	CORD, POWER	
23	CMD1A376	SUPPORT, LED	
24	HGK1A102ZA	INPUT KNOB ASSY	
25	CMH1A226	SUPPORT, PCB	
26	HNVFS2020VENICE	DAB, MODULE	
27	CNVMB114MA18L	TUNER MODULE (EUR)	
28	CMC1A253	PLATE, EARTH	
29	CGX1A304	SHEET, SENSOR	
F901	△ KBA2C1000TLEZ	FUSE	
	KJP14TT152ZY	PIN HEADER	
	CWC1C4A17B120B	CARD, CABLE	



# 4 PC BOARDS AND PARTS LIST

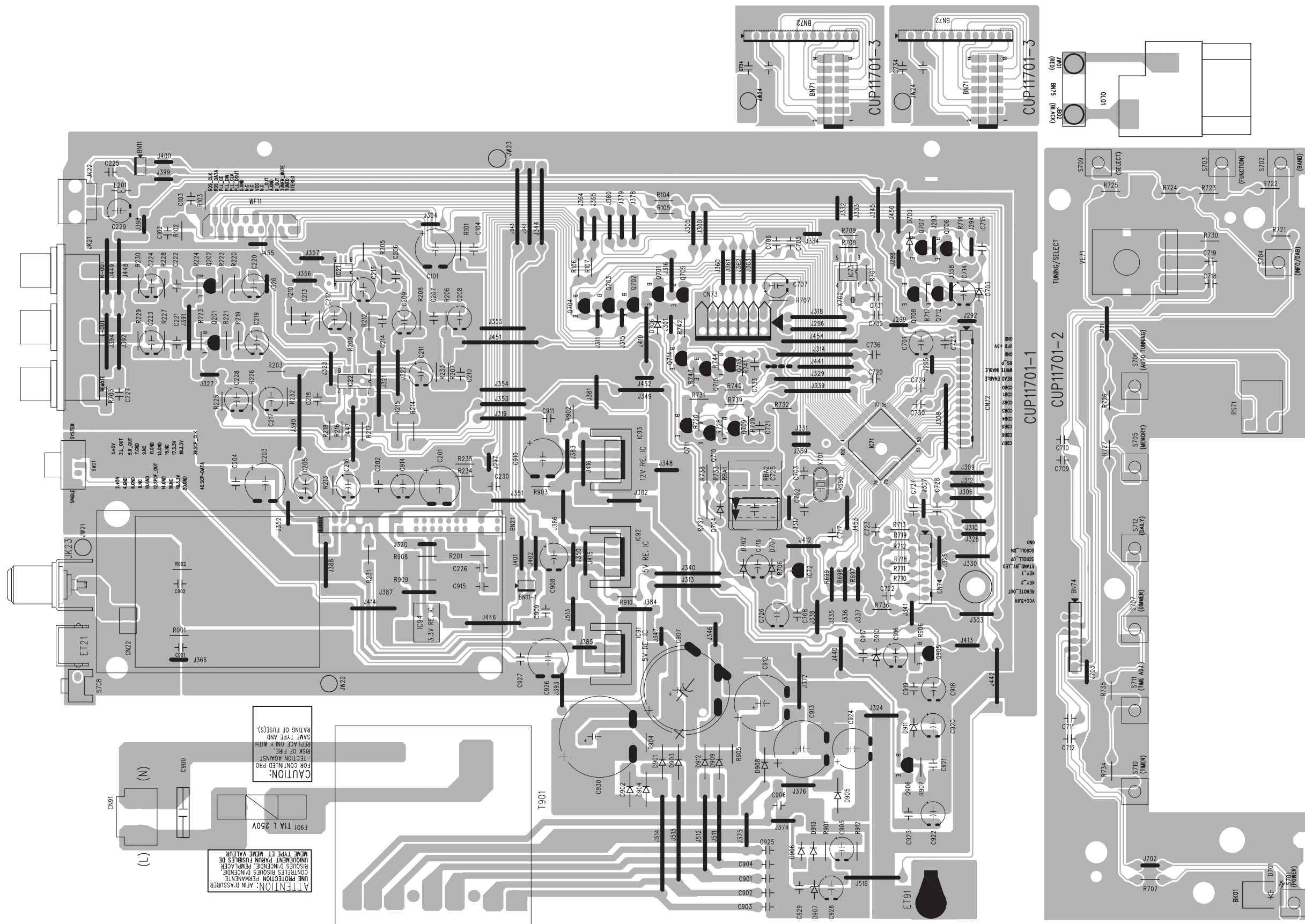

## DAB PCB ASSY (GATHER)

REF. NO.	PARTS NO.	DESCRIPTION
	COP11701B	PCB ASSY, DAB
	CUP11701Z	PCB, DAB MAIN
	CMC1A253	PLATE, EARTH
	CMD1A376	SUPPORT, LED
BN21	CJP44TT153ZY	PIN HEADER
BN71	KJP14TT152ZY	PIN HEADER
C900	△ BC0E2E104KDE	C, LINE ACROSS 0.1UF 250V
C907	△ HCEA1CH103E	C, ELECT 1000UF 16V
C912	△ HCEA1EH222E	C, ELECT 2200UF 25V
C913	△ HCEA1CH102E	C, ELECT 1000UF 16V
C924	△ HCEA1CH471T	C, ELECT 470UF 16V
CN22	KJP02TT155ZY	PIN HEADER
CN72	KJP14GA19ZM	WAFER
CN73	KJP07HA37ZM	WAFER
CN74	KJP08GA19ZM	WAFER, MOLEX53014-0810
CN91	KJP02KA060ZY	WAFER
D701	HVD342YCTB7T089	LED, YELLOW, SLR342YCTB7
D702	HVD1SS133MT	DIODE, 1SS133T-77
D703	HVD1SS133MT	DIODE, 1SS133T-77
D704	HVD1SS133MT	DIODE, 1SS133T-77
D706	HVD1SS133MT	DIODE, 1SS133T-77
D707	HVD1SS133MT	DIODE, 1SS133T-77
D709	HVD1SS133MT	DIODE, 1SS133T-77
D901	△ KVD1N4003ST	DIODE, 1N4003
D902	△ KVD1N4003ST	DIODE, 1N4003
D903	△ KVD1N4003ST	DIODE, 1N4003
D904	△ KVD1N4003ST	DIODE, 1N4003
D905	△ KVD1N4003ST	DIODE, 1N4003
D906	HVD1SS133MT	DIODE, 1SS133T-77
D907	HVDMTZJ4. 7BT	DIODE, ZENER, MTZJ4. 7B
D908	△ KVD1N4003ST	DIODE, 1N4003
D909	△ KVD1N4003ST	DIODE, 1N4003
D910	HVDMTZJ6. 2BT	DIODE, ZENER, MTZJ6. 2B
D911	HVDMTZJ6. 2BT	DIODE, ZENER, MTZJ6. 2B
D912	△ KVD1N4003ST	DIODE, 1N4003
D913	HVD1SS133MT	DIODE, 1SS133T-77
ET21	CMD1A387	BRACKET, PCB
ET91	CNE75	PLATE, EARTH
F901	KJCF5S	HOLDER, FUSE
IC21	HVINJM2068MDTE1	IC, NJM2068MD-TE1
IC22	BV174HC4066D	IC, 74HC4066D
IC71	HVIST92F124V1T6	IC, ST92F124V1T6
IC72	HVIRE5VL28CATZ	IC, RE5VL28CATZ
IC73	HVIDS1307Z	IC, DS1307Z
IC91	CMY2A048	HEAT SINK
IC91	△ HV1KA78R05	IC, KA78R05TU
IC92	CMY2A048	HEAT SINK
IC92	△ HV1KA78R05	IC, KA78R05TU
IC93	△ HV1KA78R12	IC, KA78R12TU
IC94	△ HV1RC1117ST	IC, RC1117ST
JK21	CJJ4S003X	TERMINAL, RCA JACK
JK22	HJSTOTX179L	MODULE, OPTICAL, TOTX179L
JK23	CJJ3G012Z	ANT, TEMINAL
L201	HLQ02C2R7KT	COIL, 2.7UH K
Q201	HVTKTC2874BT	TR, KTC2874B

## DAB PCB ASSY (GATHER)

REF. NO.	PARTS NO.	DESCRIPTION
Q202	HVTKTC2874BT	TR, KTC2874B
Q701	HVTKRA107MT	TR, KRA107M
Q702	HVTKRA107MT	TR, KRA107M
Q703	HVTKRA107MT	TR, KRA107M
Q704	HVTKRA107MT	TR, KRA107M
Q705	HVTKRA107MT	TR, KRA107M
Q706	HVTKRC107MT	TR, KRC107M
Q707	HVTKRA107MT	TR, KRA107M
Q708	HVTKRC107MT	TR, KRC107M
Q709	HVTKRC107MT	TR, KRC107M
Q710	HVTKRC107MT	TR, KRC107M
Q711	HVTKRC107MT	TR, KRC107M
Q712	HVTKRA107MT	TR, KRA107M
Q905	△ HVTKTC3198YT	TR, KTC3198Y
Q906	△ HVTKTA1266YT	TR, KTA1266Y
RBA1	HABGP40BVH3A3H	BATTERY, RECHARGEABLE
RS71	KRVH1M602H32	SENSOR, REMOCON
S701	HST1A016Z	SW, TACT, SKQNAED010
S702	HST1A016Z	SW, TACT, SKQNAED010
S703	HST1A016Z	SW, TACT, SKQNAED010
S704	HST1A016Z	SW, TACT, SKQNAED010
S705	HST1A016Z	SW, TACT, SKQNAED010
S706	HST1A016Z	SW, TACT, SKQNAED010
S707	HST1A016Z	SW, TACT, SKQNAED010
S709	HST1A016Z	SW, TACT, SKQNAED010
S710	HST1A016Z	SW, TACT, SKQNAED010
S711	HST1A016Z	SW, TACT, SKQNAED010
S712	HST1A016Z	SW, TACT, SKQNAED010
SW21	KSS2B016Z	SW, SLIDE
T901	△ CLT5M026ZE	TRANS, POWER
VE71	HSR2A006Z	VR, ENCODER, EC16B1220408A
WF11	KJP17GA115ZG	WAFER, CARD CABLE
X701	HOX04000E150C	CRYSTAL, 4MHZ
X702	HOX00032K120I	CRYSTAL, 32.768KHZ

## 5 INCLUDED ACCESSORIES

### INCLUDED ACCESSORIES

REF. NO.	PARTS NO.	DESCRIPTION	REMARKS
	CQX1A921Z	OWNER'S MANUAL	
	CJS4M016Z	CORD, PIN (1WAY)	
	CJS4N014Z	CORD, PIN	
	CSA1A018Z	FM 1 POLE ANT	
	CSA1A020Z	AM LOOP ANT	
	CSA272	ANT, DAB T	

# TEAC BLOCK DIAGRAM T-H300DABmkII

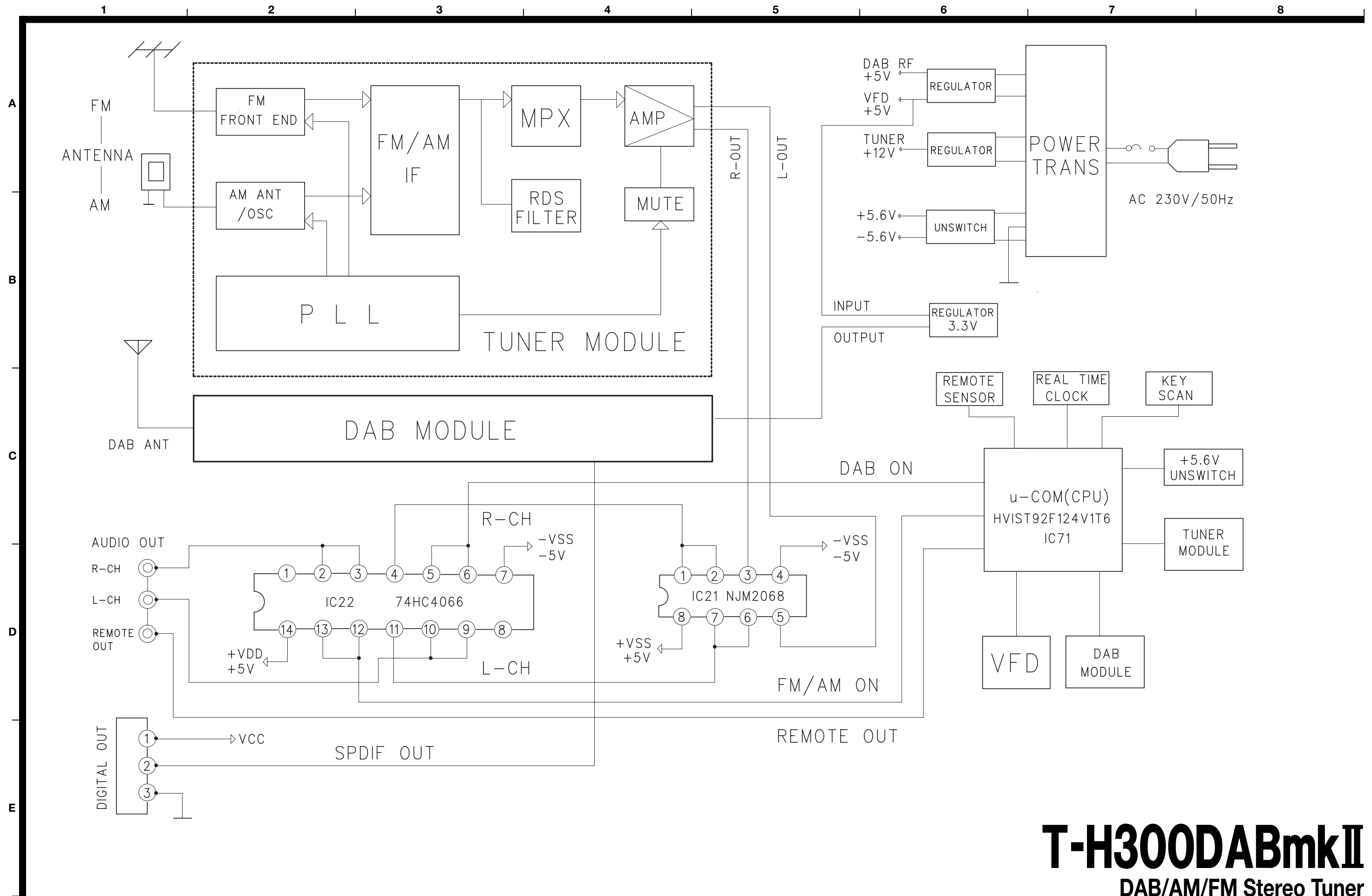

# T-H300DABmkII

DAB/AM/FM Stereo Tuner

1st Issue; July 2004

**TEAC** WIRING DIAGRAM **T-H300DABmkII**

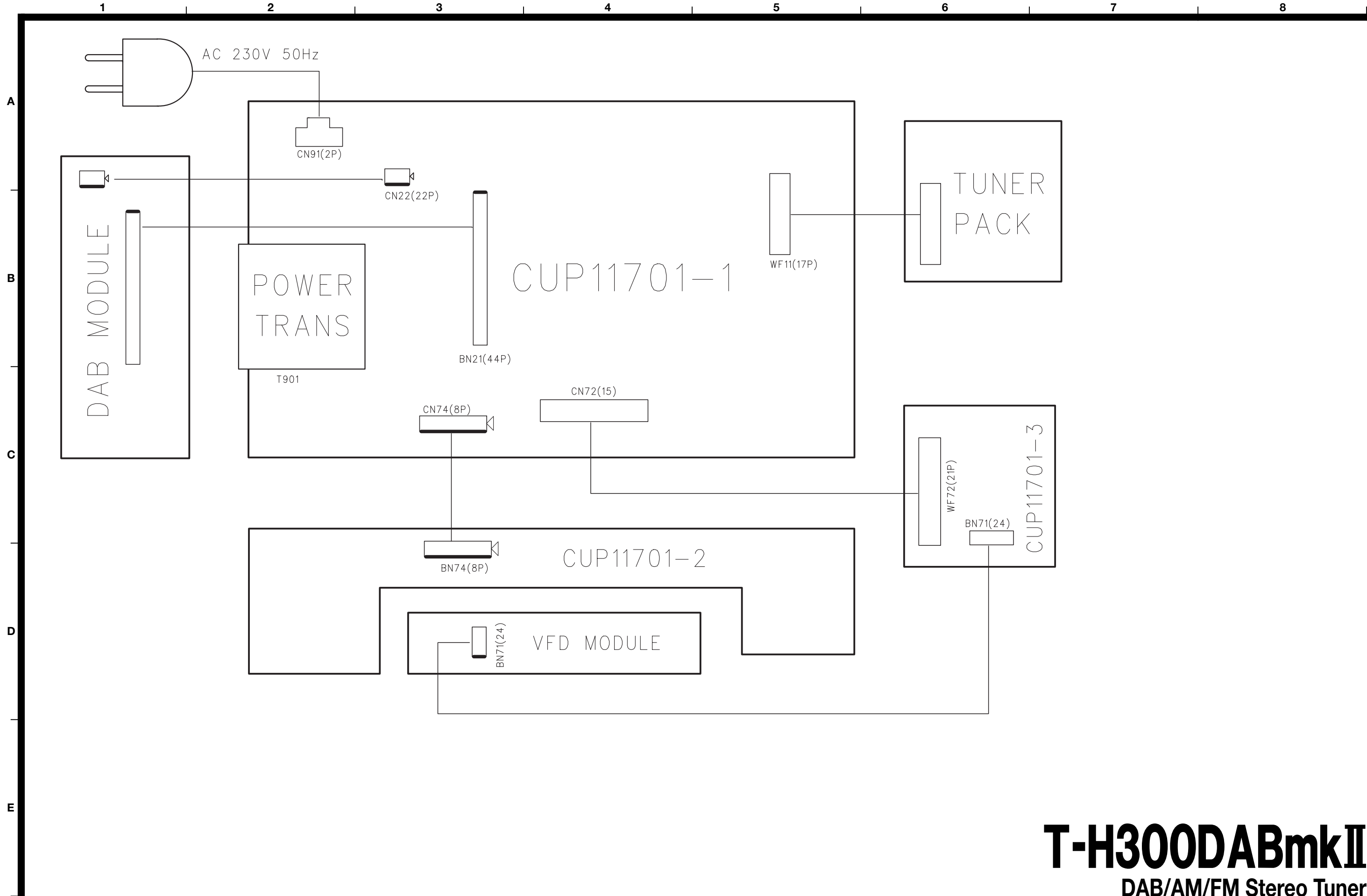

**T-H300DABmkII**

DAB/AM/FM Stereo Tuner

1st Issue; July 2004

# TEAC SCHEMATIC DIAGRAM T-H300DABmkII

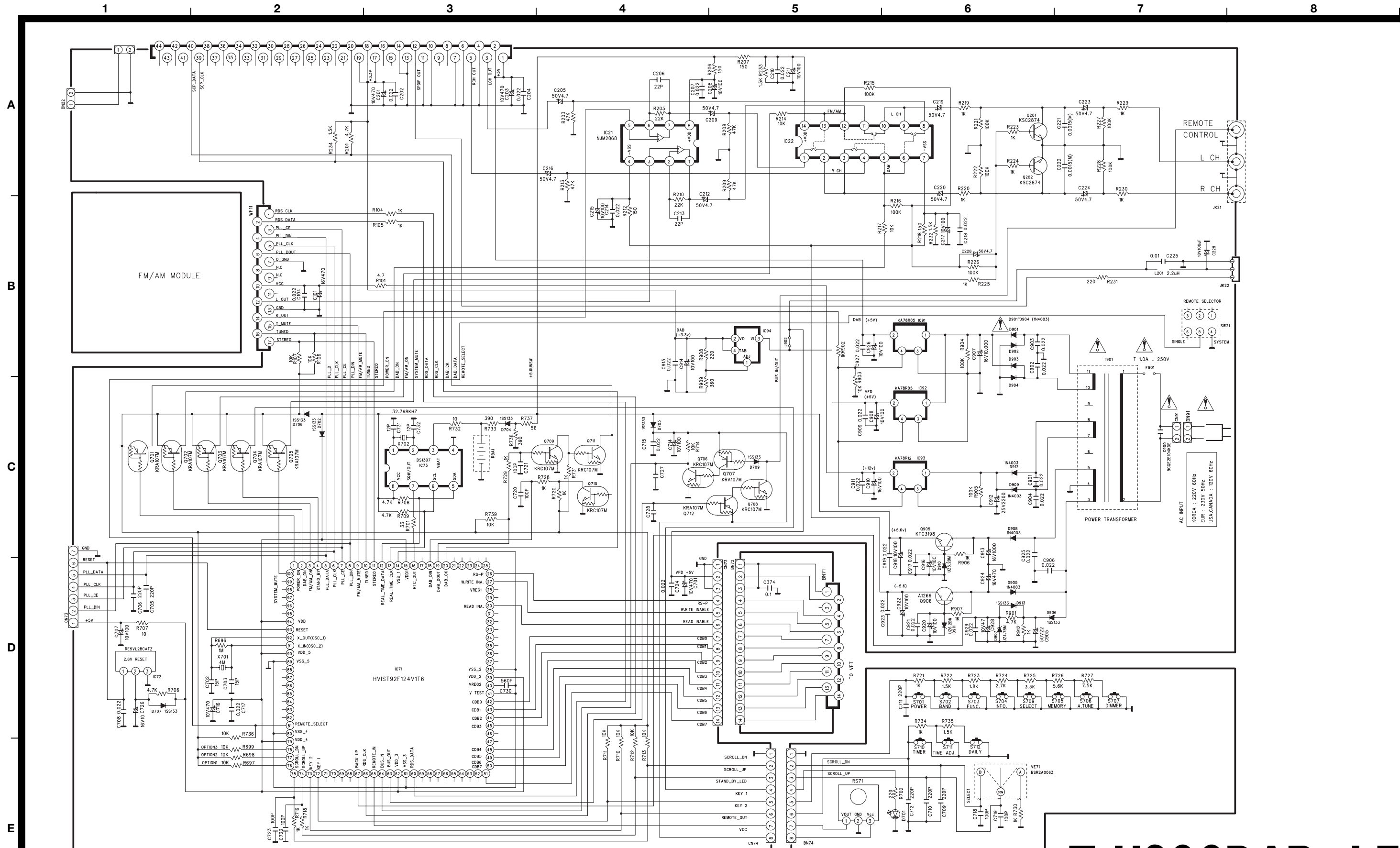

**NOTES:**  
 1. Resistor values are in ohms (k=kilo-ohms, M=megohms).  
 2. Capacitor values are in microfarads (p=picofarads).  
 3. ⚠️ Parts marked with this sign are safety critical components. They must always be replaced with identical components-refer to the appropriate parts list and ensure exact replacement.

# T-H300DABmkII

## DAB/AM/FM Stereo Tuner

1st Issue; July 2004